

INSTALLATION DOCUMENTATION	1/03/2006	P&P KIT	Kawasaki ZX10R 2003-2004-2005
Installation procedure for MXL Strada / MXL Pista Kawasaki ZX6R-ZX6RR - 2003-2004-2005 kit – Version 1.02			

MXL Strada / Pista Plug and Play kit for Kawasaki ZX-10 R

Please note: this kit is intended only for bikes completely following the service manual.



MXL STRADA DASH

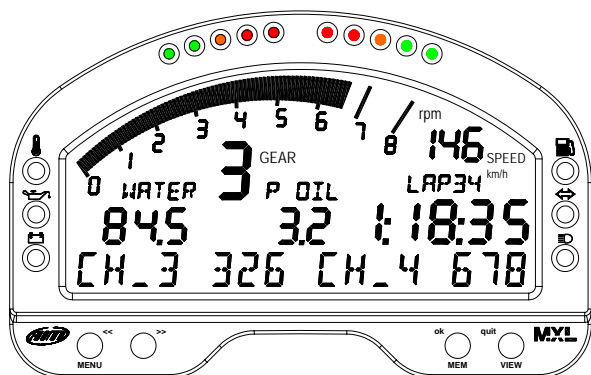

It works like a dash with 6 already configured channels that show:

- RPM
- Speed
- Water Temperature
- Oil Pressure
- Fuel Level
- Turning Lights
- High Beam
- Engaged Gear Number
- **MXL Strada** can also receive a beacon signal, records RPM, speed, water temperature and oil pressure max and min value and has **2 other free channels**.

MXL PISTA DASH AND DATA LOGGER

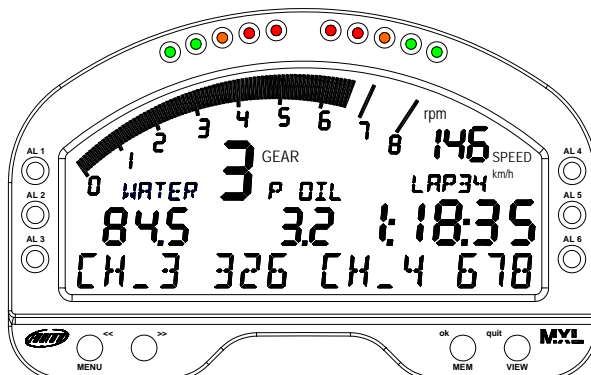

It works both like a dash and like a data logger and has two configured channels. It shows:

- RPM
- Speed
- Water Temperature
- Engaged Gear Number
- **MXL Pista** can also receive a beacon signal and has **6 free channels**.

KIT DESCRIPTION

The kit for **Kawasaki ZX-10R** is composed of the following objects:

MXL Strada Kit

- **MXL Strada**
- Plug & play wiring for **MXL Strada**
- Installation kit with a dedicated bracket
- USB Cable for Pc interface.
- CD-ROM with **Race Studio 2** software.
- Infrared beacon receiver and transmitter (**Optional**)
- Documentation.

MXL Pista Kit

- **MXL Pista.**
- Plug & play wiring for **MXL Pista.**
- Installation kit with a dedicated bracket
- Infrared beacon transmitter and receiver
- USB cable for Pc interface and data download
- CD-ROM with **Race Studio 2** software.
- Documentation.

MXL^(*) kit for **Kawasaki ZX-10R** has been developed for the following years models.

Cubic capacity (cc)	Year 2002	Year 2003	Year 2004	Year 2005
ZX-10R (1000 cc)	•	√	√	√

√ = supported

• = NOT supported

(*) When you find **MXL** this means we are speaking of **MXL Pista** and **MXL Strada**.

MXL Strada / MXL Pista - Kawasaki ZX-10R has been designed and developed to be a “plug and play” system to connect to the “on-board” wiring. The aim of this kit is to merge the functionalities of the stock dash with these of a professional data acquisition system.

MXL Strada / MXL Pista - Kawasaki ZX-10R version may be used both on track (lap times, split times, engine parameters, gyroscope to track maps) and on street (odometer, water temperature, oil pressure alarm, fuel level). The gauge, as the stock dash, is powered by the bike’s master switch.

The gauge has to be connected to the standard head light using the bracket supplied with the system. The bracket is made in anodized Aluminum, lightweight and mechanically resistant.

GENERAL NOTES – Read this before installing the system

- Do not cut any wiring: the wiring supplied with the kit is plug and play.
- Please be careful not to damage the on-board connectors when plugging / unplugging them. In the following pages is described how to correctly manage them.
- Do not install the system when the engine is hot. The on-board connectors are quite near to the engine and you can burn yourself.
- The space under the gas tank is quite confined: be careful not to hurt yourself when plugging and unplugging the connectors.
- Be careful not to loose screws and washers nor to damage the fairing when installing / uninstalling it.

INSTALLATION STEP # 1 – Removing front transparent fairing and mirrors.

The first installation step consists in removing the bike front transparent fairing and the lateral mirrors.

The front transparent fairing is fixed to the bike chassis through 6 screws circled in **Figure 1**. Please unscrew them and remove the front transparent fairing.



Figure 1: front transparent fairing – screws location

It is now necessary to remove both lateral mirrors.

First of all, please remove the two internal screws (one of them is circled in **Figure 2** while the other is nearby) and remove the lateral mirror. Please repeat this operation for both mirrors.



Figure 2: .internal screw to remove.

INSTALLATION STEP # 2 – Removing the stock dash.

The second installation step consists in removing the stock dash. To do so you need to slacken the lateral fairing. Once removed the lateral mirrors, please remove the central external screw you see circled in **Figure 3**. Please repeat this operation for both lateral mirrors.



Figure 3: central external screw.

Now please slacken the lateral fairings and remove the screw circled in **Figure 4**. Please repeat this operation on both sides of the bike.

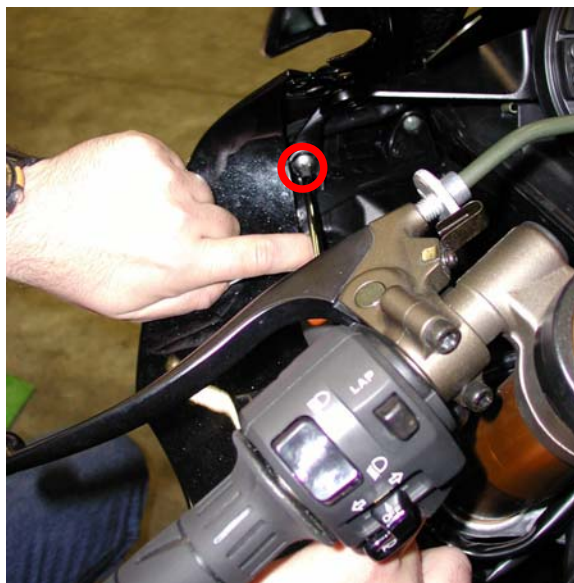

Figure 4: Location of the little internal fairing screws

The stock dash is fixed to the bike through three screws that fix the dash to an internal chassis. To remove the stock dash you need to unthread both dash and internal chassis. To do so, please remove the three screws circled in **Figure 5**. It is now possible to unthread the chassis and the stock dash



Figure 5: the screws that fix the stock dash to an internal chassis

Once the chassis and the stock dash have been unthread from the bike you need to separate them unscrewing the three screws highlighted in **Figure 6**.

When the stock dash and the chassis has been separated, **please remount the chassis on the bike without any dash**, using the screws you removed before (see **Figure 5**).



Figure 6: screws that fixes the stock dash

INSTALLATION STEP # 3 – Assembling the kit.

The third installation step consists in assembling **MXL Strada / MXL Pista** kit.

First of all, please fix the anchor plugs you find in the kit on the three related holes of the bracket, as in **Figure 7**.

The other four holes, circled and highlighted by two arrows in the figure on the right, are used to fix **MXL Strada / MXL Pista** to the same bracket.



Figure 7: Anchor plugs are fixed to the bracket

The kit You receive, has already mounted the four anti-vibration mountings on the back of your **MXL**;

Install **MXL** on the aluminium bracket fixing the bracket to it in correspondence of the 4 anti-vibration mounting and using 4 screws and 4 Grover washers.

Figure 8 shows the correct assembly of **MXL Strada / MXL Pista**, bracket and washers (rear view).

The anchor plugs, red circled in the figure, are to be inserted in the holes of **Figure 6**.

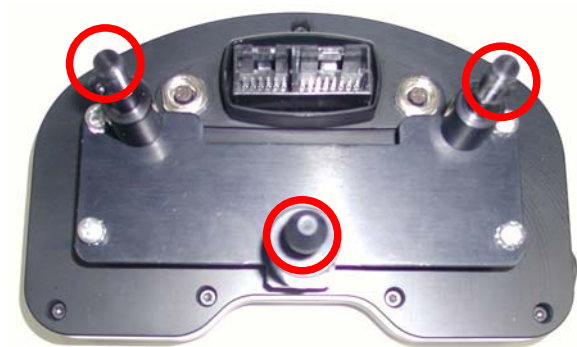

Figure 8: assembled kit, rear view.

INSTALLATION STEP # 4 – Wiring connection

The fourth installation step consists in installing **MXL Strada / MXLPista** wiring. First of all, please pull back the protective plastic cover highlighted with an arrow in **Figure 9** and plug the stock connector in the kit one; then replace the plastic cover. **Please note:** if you bought an **MXL Pista** you will find in the kit the **TPS wiring** too. This cable will be connected later and we suggest to leave it with the connectors looking the right side of the bike.

Once the wiring connected, you can install **MXL** on your bike inserting the three anchor plugs (red circled in **Figure 8**) in the related holes (highlighted in **Figure 6**).

Figure 10 shows **MXL** correctly installed.



Figure 9: wiring connection



Figure 10: MXL correctly installed.

INSTALLATION STEP # 5 – Connecting the TPS cable.

If you bought an **MXL Pista** you will find in the kit **AIM TPS cable** too (shown in **Figure 11**). This cable is a split one and is made of two connectors: a male connector (labelled as “**AIM – M**” in **Figure 11**) and a female one (labelled as “**AIM – F**” in **Figure 11**). To connect it, please follow carefully these instructions.

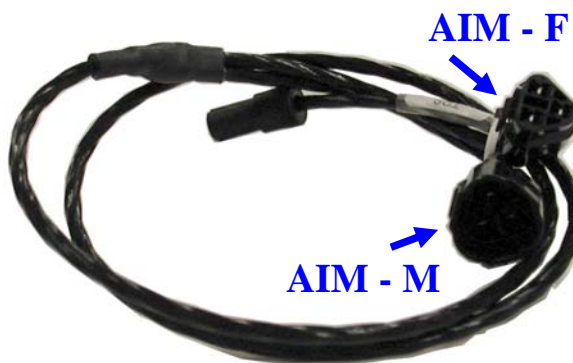

Figure 11: AIM TPS Cable

To find the stock **TPS** connector you need to remove the bike seats, the gas tank and the Airbox.

The passenger seat is fixed to the bike with a bolt, please unthread it from the bolt. In **Figure 13** you see the bike without the passenger seat. The bolt is highlighted with an arrow.



Figure 12: Passenger seat

Once the passenger seat has been removed, you need to remove the little plastic chassis that is located between driver seat and passenger one. This plastic chassis is fixed to the bike with two screws red circled in **Figure 13**. Please remove the screws and then remove the little plastic chassis.

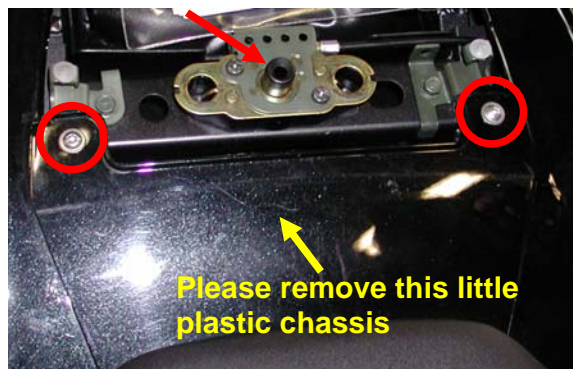

Figure 13: the passenger seat has been removed

When the little plastic chassis has been removed, you need to unscrew the two screws that fix the driver seat to the bike. These screws are covered by two lateral plastic fairings, fixed to the bike chassis by two lateral screws. The **first screw** is circled in **Figure 14**, while **the second** is specular on the other side of the bike. Under the plastic lateral fairings you find two other screws, one for each side of the bike. Please remove them and remove the driver's seat.



Figure 14: the screw that fixes the plastic fairing to the bike chassis

When the bike seats have been removed it is necessary to remove the gas tank. In **Figure 15** is circled one of the screws that fix the gas tank to the bike, please unscrew it.

Please remember not to do this installation when the bike is hot, because the available space is quite reduced and you can burn yourself.



Figure 15: one of the screws that fix the gas tank.

Now, please remove the black connector located on the left side of the bike behind the gas tank, red circled in **Figure 16**.

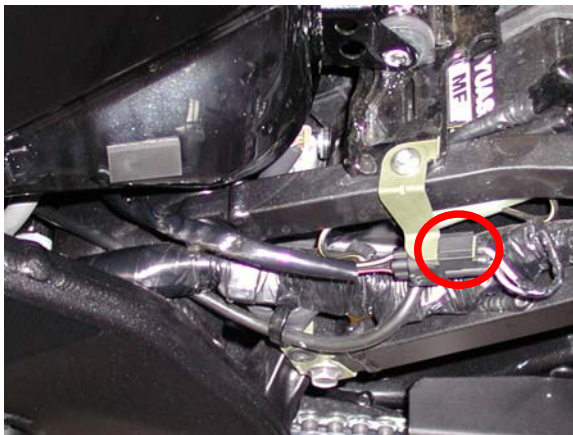

Figure 16: this black connector has to be removed

In **Figure 17** are shown the two screws that fix the gas tank to the bike chassis. Please remove them.

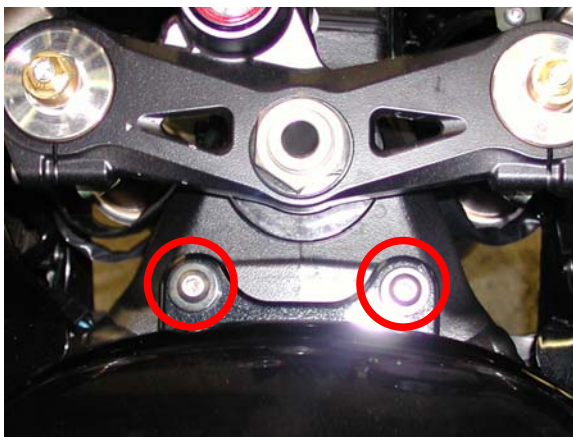

Figure 17 these screws have to be removed

In **Figure 18** is highlighted the fuel hose. To remove the gas tank this tube has to be removed. To do so, please refer to **Figure 19**.



Figure 18: the hose that takes the fuel to the engine

In **Figure 20** are highlighted with two arrows two tongues. To unplug the fuel hose, please press them and the fuel hose will be unplugged. Now you can remove the gas tank. Please do so.

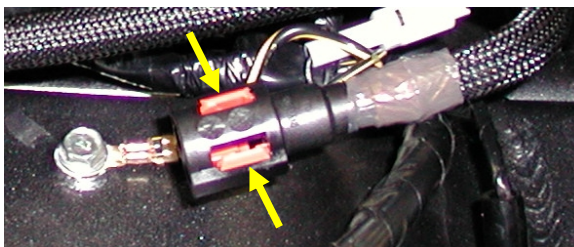

Figure 19: please press these tongues.

Once the gas tank has been removed the bike is as in **Figure 20**. It is now necessary to remove the Airbox. To do so, please remove the eight screws red circled in **Figure 20**.

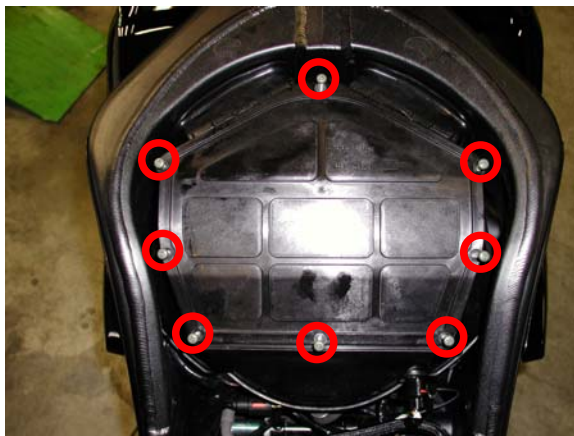

Figure 20: Location of the Airbox screws.

To remove the Airbox, please follows these steps:

- remove the screws red circled in **Figure 21**.
- pull back the black lateral pipe unions, highlighted by two blue/yellow arrows in **Figure 21**.
- counter-clockwise rotate the Airbox.

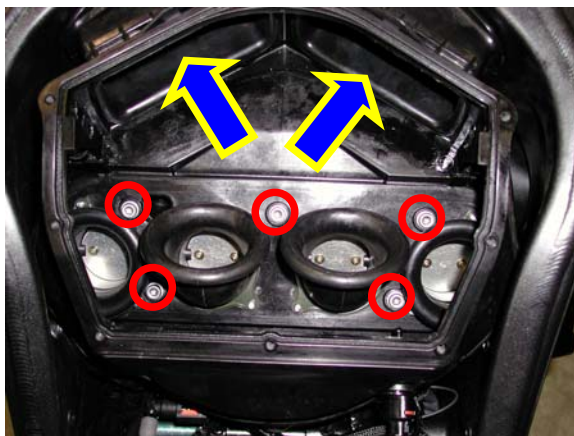

Figure 21: the Airbox

Once the Airbox has been removed, you can finally find the TPS connector, that is red circled in **Figure 22**.

The stock **TPS connector** is a male one. Please unplug it and connect it to the AIM female connector (labelled as “**AIM - F**” in **Figure 11**); then connect the other connector, female type, with the AIM male connector (labelled as “**AIM - M**” in **Figure 11**)

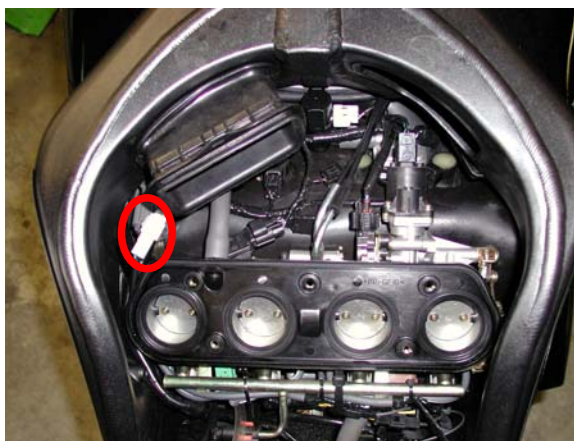

Figure 22: the TPS connector

PLEASE NOTE: before re-mounting the mirrors, the front transparent fairing, the seats, the gas tank and the Airbox, we suggest You to turn on the bike in order to check the system integrity and its correct working.

FIRMWARE FOR MXL Strada / MXL Pista Kawasaki ZX 10R - 2003-2004-2005

As your **MXL Kawasaki** has been designed both for street and track use and as the information the driver needs are different, your **MXL Kawasaki** is equipped with a special firmware version which provides you with a **second virtual dashboard**.

When you are driving on a street, the display is set to “**street mode**” and shows the following parameters:

- RPM graphical bar: settable upper limit;
- RPM digital value / Battery voltage / Total odometer / Partial odometer / Current date and time: Fuchsia colour (button **VIEW/QUIT** to switch them);
- Speed: red colour;
- Gear number: green colour;
- 2 fixed analog inputs: Blue colour
- 4 analog inputs displayed two by two or static string: Light Blue colour.



Figure 23: Street display

Once you start running on a track and your gauge triggers a lap (you pass in front of a switched-on lap transmitter), the display switches automatically to “**track mode**” and shows the following parameters:

- RPM graphical bar: settable upper limit;
- Lap time / RPM digital value / Battery voltage / Current date and time: fuchsia colour (button **VIEW/QUIT** to switch between them);
- Speed: red colour;
- Gear number: green colour;
- 2 fixed analog inputs: Blue colour
- 4 analog inputs displayed two by two or static string: Light Blue colour.



Figure 24: Track display

In order to step back from “**track mode**” to “**street mode**”, please switch off the gauge and then re-switch it on. The gauge sets automatically to “**street mode**”.

NOTE: for further information concerning the display management and its configuration, please refer to the **MXL Strada / Pista / PRO** user’s manual.

MXL Strada / MXL Pista KAWASAKI CONFIGURATION [RACE STUDIO 2]

Your **MXL Pista / MXL Strada Kawasaki** may be interfaced with the PC in order to:

- download the data stored in the internal memory;
- upgrade the gauge firmware;
- configure the gauge.

Once you buy a **MXL Pista / MXL Strada Kawasaki**, the gauge includes a configuration properly developed a **Kawasaki ZX6R-6RR**. For a **Kawasaki ZX10R** you only need to set RPM max value and shift lights

If you wish to change any other value, to add a potentiometer or a gyroscope to your **MXL Pista / MXL Strada Kawasaki** and you need to calibrate them, if you change the crown or the pinion with a “different teeth number” one, you need to use our software **Race Studio 2**.

The CD-ROM including software, USB drivers, installation documentation and user manual is included in **MXL Pista / MXL Strada Kawasaki** kit. If you have any doubt about software or USB drivers installation, please refer to the installation manual included in the CD-ROM.

The following table shows the input channels for **MXL Pista / MXL Strada Kawasaki**.

MXL Pista - Kawasaki

Ch. 1	Water temperature
Ch. 2	Free input channel – use RS 2 ^(*)
Ch. 3	Free input channel – use RS 2 ^(*)
Ch. 4	Free input channel – use RS 2 ^(*)
Ch. 5	Free input channel – use RS 2 ^(*)
Ch. 6	Free input channel – use RS 2 ^(*)
Ch. 7	Free input channel – use RS 2 ^(*)
Ch. 8	“On board” gear sensor

MXL Strada - Kawasaki

Ch. 1	Water temperature
Ch. 2	Free input channel – Use RS 2 ^(*)
Ch. 3	Oil Pressure
Ch. 4	Free input channel – Use RS 2 ^(*)
Ch. 5	Fuel Level
Ch. 6	Turning Lights
Ch. 7	High Beam
Ch. 8	“On board” gear sensor

^(*) RS2 = **Race Studio 2** software

To correctly configure your gauge and use **Race Studio 2**, please follow these instructions.

Run **Race Studio 2** and select “**MXL**” pushbutton in the buttons toolbar. Press “System manager” button and then “New” button: the screenshot shown in **Figure 25** is prompted.

Please, set all configuration parameters (Logger type, Vehicle name, speed, temperature and pressure unit of measure, etc...) and then press OK button.

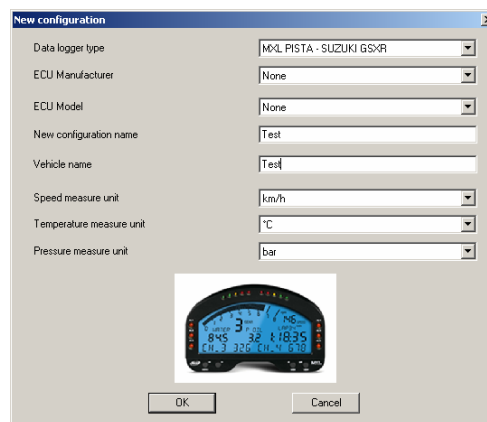

Figure 25: Race Studio 2 – New configuration

Once pressed OK button, System Manager window is prompted on your monitor, as shown in **Figure 26**.

In order to correctly configure the input channels, please select a configuration among the available ones (in **Figure 26**, for instance, there are 2 available configurations: the yellow-highlighted is the selected one) and press button “Channels”.

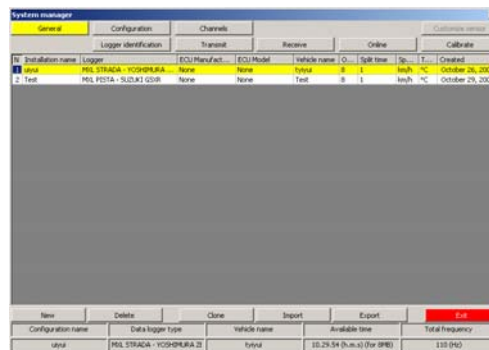

Figure 26: Race Studio 2 – System manager window

The screenshot in **Figure 27** is prompted.

MXL Strada Kawasaki:

The logger has 2 free input channels, Channels labelled as CH. 2 and CH. 4. Clicking in the correspondent cell (row “CH. 2” or “CH. 4” column sensor type) you may set the input channels among a long list of pre-defined sensors or set a custom sensor selecting “custom sensor manager”.



Figure 27: Race Studio 2 – Input channels window

MXL Pista Kawasaki:

The logger has 6 free input channels, labelled from CH. 2 to CH. 7. Clicking in the correspondent cell (row “CH 2 / CH. 7” column “Sensor type”) you may set the input channels among a long list of pre-defined sensors or set a custom sensor selecting “custom sensor manager”. Moreover, you may set channel name and sampling frequency.

Once all sensors have been correctly set, please press “Configuration” button.

Configuration window (**Figure 28**) allows you to set shift lights and alarms threshold value, change unit of measure, modify the speed parameters, etc...



Figure 28: Race Studio 2 – Configuration window

Speed:

The speed sensor on your **Kawasaki** bike is installed on the jackshaft that connects the gearbox to the pinion. The number of magnets installed on this jackshaft is **4**. The wheel circumference written in the proper cell is an “equivalent circumference” calculated using the following formula:

$$Equiv\ Circumf = \frac{Wheel\ Circumf * N_p}{N_c}$$

N_p = Pinion teeth number
 N_c = Crown teeth number

Using the default values for crown/pinion teeth number and wheel circumference for a **Kawasaki**, the equivalent circumference is **824 mm (32.44 inches)**. If you change the pinion or the crown and you do not want to manually compute the equivalent circumference, please refer to “[Equivalent Circumference Compute](#)” paragraph.

In case of ZX-R 2005, the reference number of teeth is 21 and the signal is taken from the secondary transmission jackshaft





Shift lights:

The values in the 5 cells may be modified to switch on the led at the desired RPM value. The 5 default values are the proper ones for a **Kawasaki ZX6R-6RR**. For a **Kawasaki ZX10R** we suggest you to set (from led 1 onward): 9.500, 10.000, 10.500, 11.000 and 11.500.

RPM:

Please, DO NOT modify the “Multiply factor” (default value is **/2**). To change RPM upper value, please select the desired value among the 7 available. We suggest you to set 12.000.

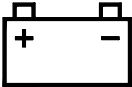
Alarm Leds **MXL Strada Kawasaki**:

AL 1		Water Temperature	Maximum alarm Default value: 100 °C (194 °F)
AL 2		Oil Pressure	Minimum alarm Default value: 2 Bar (29 PSI) .
AL 3		Battery Voltage	Minimum alarm Default value: 13 V .
AL 4		Fuel Level	Minimum alarm Default value: 100 (corresponding to the stock dash fuel reserve value). Do NOT modify the value; you might run out of fuel.
AL 5		Turning Light	Minimum alarm Default value is 250 Do NOT modify the value; you might not see the turn signal on the display.

AL 6



High Beam

Maximum Alarm
Default value is **250**
Do NOT modify the value

Alarm Leds **MXL Pista Kawasaki**:

AL 1



Water Temperature

Maximum alarm
Default value: **100 °C (194 °F)**

From AL 2 to AL 6

You can insert the proper threshold value for the sensors you have installed on each channel.

Gear sensor:

Kawasaki plug & play kit samples the gear from an “on-board” neutral sensor installed inside the gearbox. To allow **MXL** sampling the gear, please do NOT modify the gear sensor default value which is set to **calculated with neutral signal**.

Calibrating auto-calibrating the sensors and transmitting the configuration.

MXL PISTA Kawasaki owners:

If you have installed a gyroscope (to map tracks) and/or a fork travel potentiometer (or a rear shock travel potentiometer), these sensors have to be calibrated to sample correct data. Please, click on the “Calibrate” button: the screenshot shown in **Figure 30** appears.

The sensors are divided in 2 categories: the “to be auto-calibrated” sensors and the “to be calibrated” ones.

The “to be auto-calibrated sensors” are:

- Gyroscope
- Potentiometer distance

The “to be calibrated sensors” are:

- Zero based potentiometer
- Mid zero potentiometer

For more information about calibration/auto-calibration procedure, please refer to the user’s manual. Once finished calibrating / auto-calibrating the sensors, you have to transmit the configuration to the logger pressing button “Transmit calibration” inside the “Sensor calibration” window.

Once you set the input channels on **MXL Strada / MXL Pista Kawasaki** and/or set the threshold values for the alarm led of the shift lights, **please transmit the configuration to the logger pressing OK button and then “Transmit” button on the next window.**

ATTENTION: before transmitting the configuration, please ensure that the logger is switched on and connected to a switched on PC as in **Figure 30**.

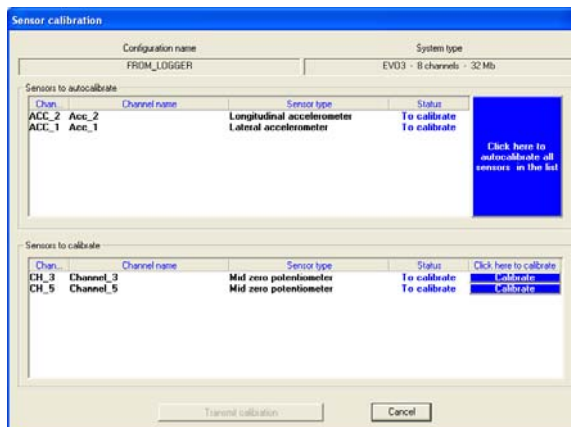

Figure 30: Race Studio 2 – Calibration window

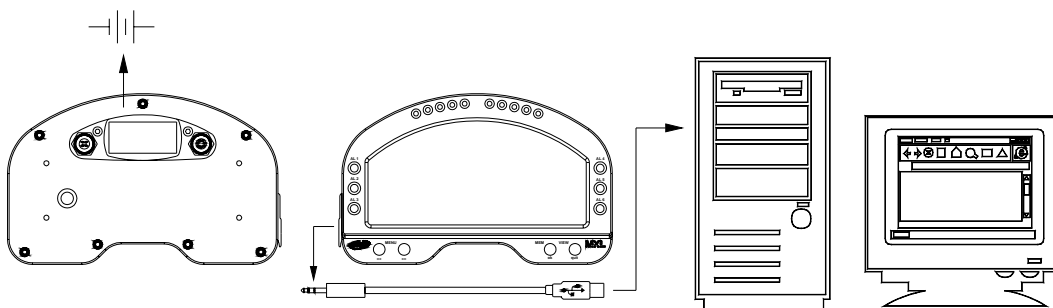

Figure 29: How to connect the logger to the PC

EQUIVALENT CIRCUMFERENCE COMPUTE

If you need to compute the equivalent circumference to be inserted in the correspondent “Configuration” window of **Race Studio 2** software, you can use “**Bike.exe**” software you find in **Race Studio 2** software CD. To do so please browse the CD:

Double click on “**Bike.exe**” icon and the following window appears. Please:

- insert “Drive gear teeth number”
- insert “Driven gear teeth number”
- select circumference unit of measure
- insert circumference value
- press compute button

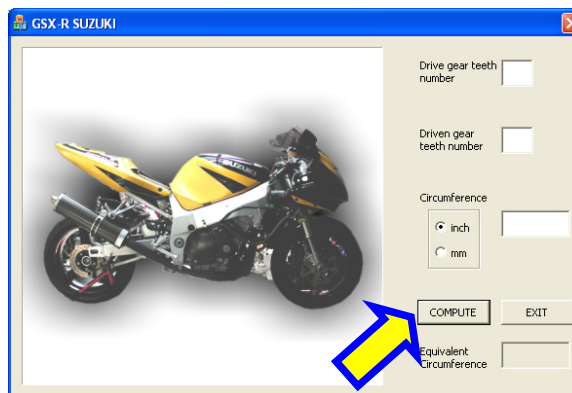

Figure 30: Bike.exe – compute window

The software computes the equivalent circumference and the final value appears in the related cell (red circled).

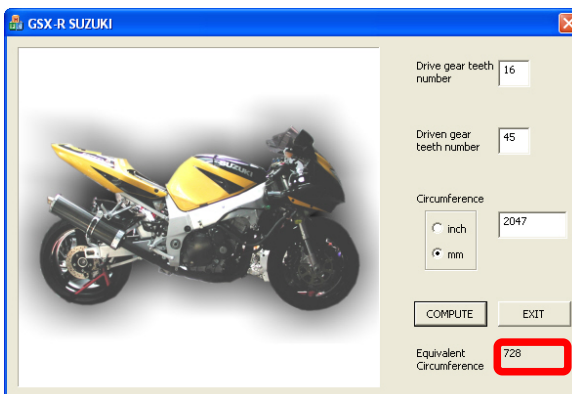

Figure 31: Equivalent circumference computed

Please insert this value in the related cell of **Race Studio 2** Configuration window.

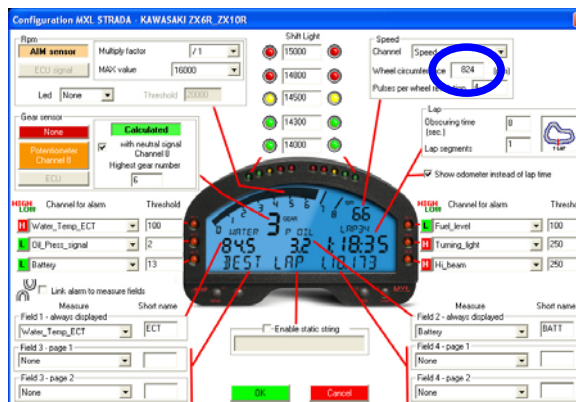

Figure 32: Race Studio 2 – configuration window

“SOFTWARE – FIRMWARE” INFORMATION, MAINTENANCE

MXL Strada/MXL Pista Kawasaki ZX10R does not need any special maintenance. Provided that adequate care is taken of display unit and components, the only required maintenance is periodical software and firmware upgrading.

This installation manual was written using the following parameters:

- **Race Studio 2 – Version 2.20.11**
- **MXL Strada/MXL Pista – Firmware version 14.32**

To know if a new software / firmware version has been released by **AIM**, please connect to our website www.aim-sportline.com and go to “Software Download” page, where all last software and firmware versions are freely downloadable.

If you find a new software / firmware version, please download and run it and then follow the instruction prompted on your Pc monitor.



TABLE OF CONTENTS

MXL Strada / Pista Plug and Play kit for.....	1
KIT DESCRIPTION.....	2
GENERAL NOTES – Read this before installing the system.....	2
INSTALLATION STEP # 1 – Removing front transparent fairing and mirrors.....	3
INSTALLATION STEP # 2 – Removing the stock dash.....	4
INSTALLATION STEP # 3 – Assembling the kit.....	6
INSTALLATION STEP # 4 – Wiring connection	7
INSTALLATION STEP # 5 – Connecting the TPS cable.	8
FIRMWARE FOR MXL Strada / MXL Pista Kawasaki ZX 10R - 2003-2004-2005	12
MXL Strada / MXL Pista KAWASAKI CONFIGURATION [RACE STUDIO 2].....	13
<i>Speed:</i>	15
<i>Shift lights:</i>	15
<i>RPM:</i>	15
<i>Alarm Leds MXL Strada Kawasaki:</i>	15
<i>Alarm Leds MXL Pista Kawasaki:</i>	17
<i>Gear sensor:</i>	17
Calibrating auto-calibrating the sensors and transmitting the configuration.	18
EQUIVALENT CIRCUMFERENCE COMPUTE.....	19
“SOFTWARE – FIRMWARE” INFORMATION, MAINTENANCE	20
TABLE OF CONTENTS	21