



AiM GPS09c Open and Pro Open Expansion



GPS09c Open and Pro Open



GPS09c Open and Pro Open, Roof version



AiM GPS09c Open and Pro Open Expansion

Dimensions

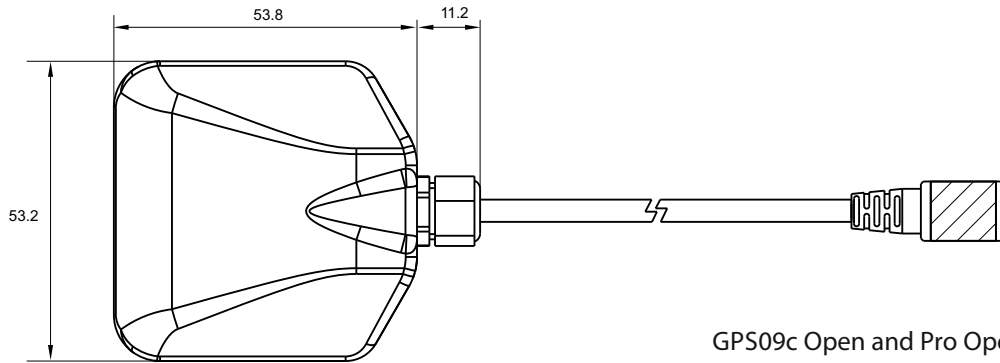
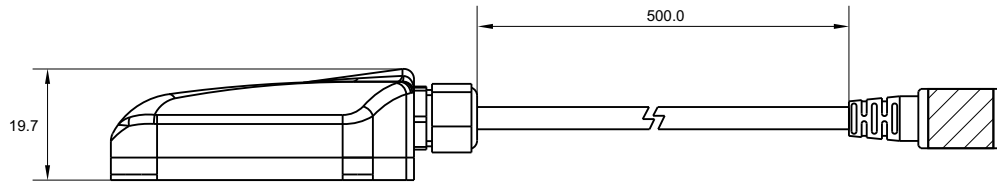

GPS09c Open and Pro Open

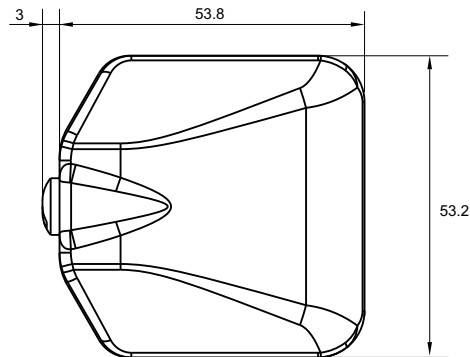
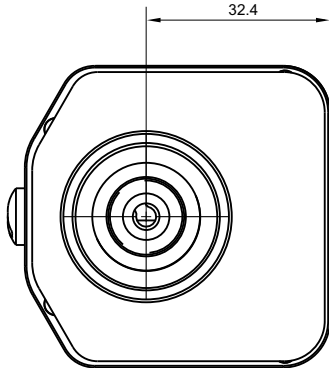

GPS09c Open and Pro Open,
Roof version

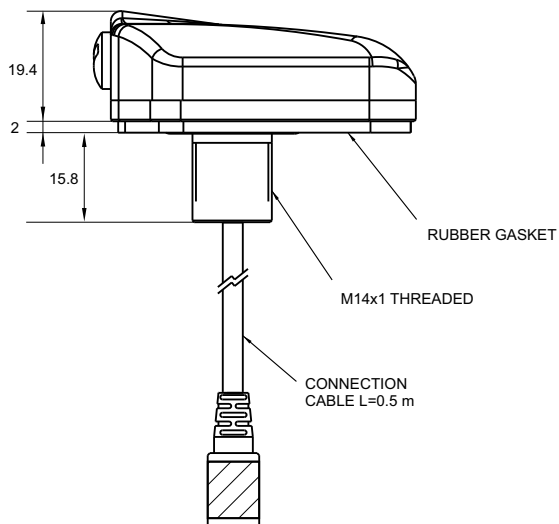

Dimensions in mm



AiM GPS09c Open and Pro Open Expansion

Pinout

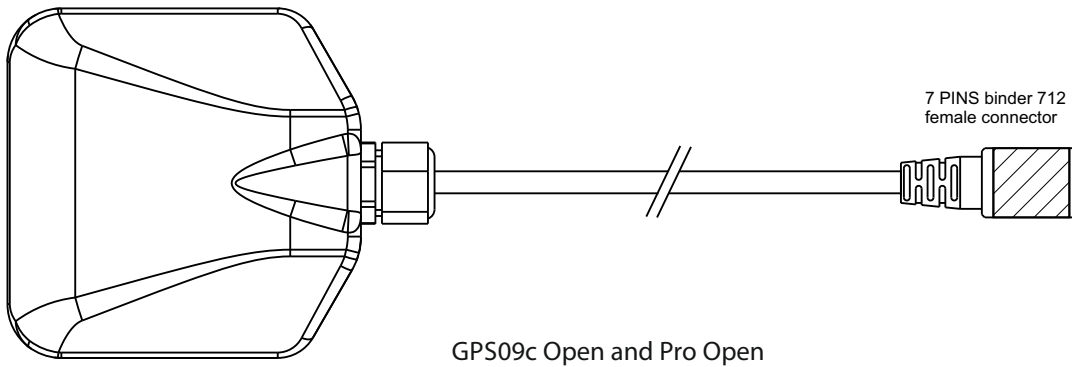

7 PINS binder 712 female connector (external view)

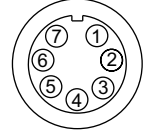

1	USB D+
2	USB D-
3	CAN L
4	CAN H
5	GND
6	RS232 TX
7	+ Vb

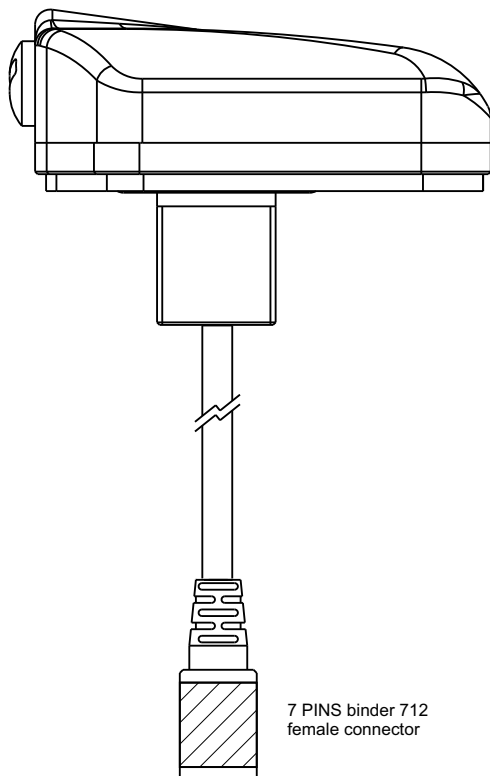

GPS09c Open and Pro Open, Roof version

7 PINS binder 712 female connector (external view)

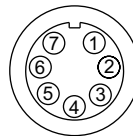

1	USB D+
2	USB D-
3	CAN L
4	CAN H
5	GND
6	RS232 TX
7	+ Vb



AiM GPS09c Open and Pro Open

Expansion

Connections

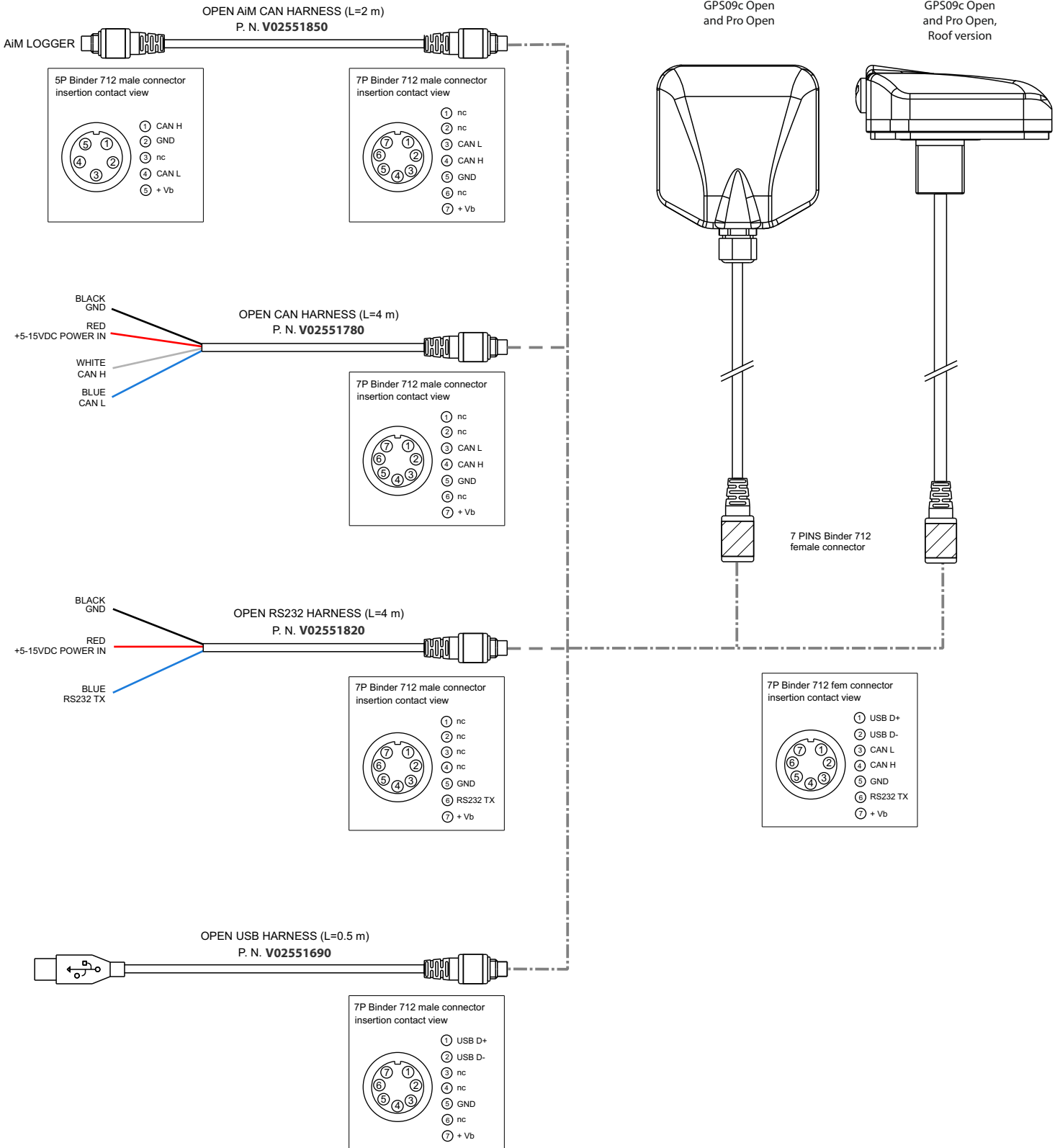



AiM GPS09c Open and Pro Open Expansion

Technical specifications

GPS09c Open

GPS	25 Hz
External power	5÷15 V
Inertial platform	No
Connection	CAN, RS232
Dimensions	53.2 x 53.8 x 19.7 mm (Open) 53.2 x 53.8 x 37.2 mm (Open Roof version)
Weight	60.5 g (Open) 100 g (Open Roof version)
Waterproof	IP65

GPS09c Pro Open

GPS	25 Hz
External power	5÷15 V
Inertial platform	100 Hz internal 3 axis ±5G accelerometer + 3 axis gyro + 3 axis magnetometer
Connection	CAN, RS232
Dimensions	53.2 x 53.8 x 19.7 mm (Open Pro) 53.2 x 53.8 x 37.2 mm (Open Pro Roof version)
Weight	60.5 g (Pro Open) 100 g (Pro Open Roof version)
Waterproof	IP65





AiM GPS09c Open and Pro Open Expansion

Kits, accessories & spare parts



GPS09c Open Module

Description	Part number	
GPS09c Open Module	X40GPS09OSSNC	



Kit 1 Open, CAN 2 m version

Description	Part number	The kit contains	
GPS09c Open + CAN Harness 2 m	X40GPS09OSSCO20	GPS09c Open 	CAN Harness 2 m 



Kit 2 Open, CAN 4 m version

Description	Part number	The kit contains	
GPS09c Open + CAN Harness 4 m	X40GPS09OSSCO40	GPS09c Open 	CAN Harness 4 m 

Kit 3 Open, CAN AiM 2 m version

Description	Part number	The kit contains	
GPS09c Open + CAN AiM Harness 2 m	X40GPS09OSSCA20	GPS09c Open 	CAN AiM Harness 2 m 

Kit 4 Open, CAN AiM 4 m version



Description	Part number	The kit contains	
GPS09c Open + CAN AiM Harness 4 m	X40GPS09OSSCA40	GPS09c Open 	CAN AiM Harness 4 m 



AiM GPS09c Open and Pro Open Expansion

Kits, accessories & spare parts



Kit 5 Open, RS232 version

Description	Part number	The kit contains	
GPS09c Open + RS232 Harness 2 m	X40GPS09OSSRS20	GPS09c Open 	RS232 Harness 2 m 



GPS09c Open Module, Roof version

Description	Part number	The kit contains	
GPS09c Open Module, Roof version	X40GPS09OSRNC		



Kit 6 Open Roof, CAN 2 m version

Description	Part number	The kit contains	
GPS09c Open Roof version + CAN Harness 2 m	X40GPS09OSRCO20	GPS09c Open Roof version 	CAN Harness 2 m 

Kit 7 Open Roof, CAN 4 m version

Description	Part number	The kit contains	
GPS09c Open Roof version + CAN Harness 4 m	X40GPS09OSRCO40	GPS09c Open Roof version 	CAN Harness 4 m 

Kit 8 Open Roof, CAN AiM 2 m version



Description	Part number	The kit contains	
GPS09c Open Roof version + CAN AiM Harness 2 m	X40GPS09OSRCA20	GPS09c Open Roof version 	CAN AiM Harness 2 m 





AiM GPS09c Open and Pro Open Expansion

Kits, accessories & spare parts

Kit 9 Open Roof, CAN AiM 4 m version

Description	Part number	The kit contains
GPS09c Open Roof version + CAN AiM Harness 4 m	X40GPS09OSRCA40	GPS09c Open Roof version  CAN AiM Harness 4 m 

Kit 10 Open Roof, RS232 version

Description	Part number	The kit contains
GPS09c Open Roof version + RS232 Harness 2 m	X40GPS09OSRRS20	GPS09c Open Roof version  RS232 Harness 2 m 





AiM GPS09c Open and Pro Open Expansion

Kits, accessories & spare parts



GPS09c Pro Open Module

Description	Part number	
GPS09c Pro Open Module	X40GPS09OPSNC	



Kit 11 Pro Open, CAN 2 m version

Description	Part number	The kit contains	
GPS09c Pro Open + CAN Harness 2 m	X40GPS09OPSCO20	GPS09c Pro Open 	CAN Harness 2 m 



Kit 12 Pro Open, CAN 4 m version

Description	Part number	The kit contains	
GPS09c Pro Open + CAN Harness 4 m	X40GPS09OPSCO40	GPS09c Pro Open 	CAN Harness 4 m 

Kit 13 Pro Open, CAN AiM 2 m version

Description	Part number	The kit contains	
GPS09c Pro Open + CAN AiM Harness 2 m	X40GPS09OPSCA20	GPS09c Pro Open 	CAN AiM Harness 2 m 

Kit 14 Pro Open, CAN AiM 4 m version



Description	Part number	The kit contains	
GPS09c Pro Open + CAN AiM Harness 4 m	X40GPS09OPSCA40	GPS09c Pro Open 	CAN AiM Harness 4 m 



AiM GPS09c Open and Pro Open Expansion

Kits, accessories & spare parts



Kit 15 Pro Open, RS232 version

Description	Part number	The kit contains	
GPS09c Pro Open + RS232 Harness 2 m	X40GPS09OPRS20	GPS09c Pro Open 	RS232 Harness 2 m 



GPS09c Pro Open Module, Roof version

Description	Part number	The kit contains	
GPS09c Pro Open Module, Roof version	X40GPS09OPRNC		



Kit 16 Pro Open Roof, CAN 2 m version

Description	Part number	The kit contains	
GPS09c Pro Open Roof version + CAN Harness 2 m	X40GPS09OPRCO20	GPS09c Pro Open Roof version 	CAN Harness 2 m 

Kit 17 Pro Open Roof, CAN 4 m version

Description	Part number	The kit contains	
GPS09c Pro Open Roof version + CAN Harness 4 m	X40GPS09OPRCO40	GPS09c Pro Open Roof version 	CAN Harness 4 m 

Kit 18 Pro Open Roof, CAN AiM 2 m version



Description	Part number	The kit contains	
GPS09c Pro Open Roof version + CAN AiM Harness 2 m	X40GPS09OPRCA20	GPS09c Pro Open Roof version 	CAN AiM Harness 2 m 





AiM GPS09c Open and Pro Open Expansion

Kits, accessories & spare parts

Kit 19 Pro Open Roof, CAN AiM 4 m version

Description	Part number	The kit contains	
GPS09c Pro Open Roof version + CAN AiM Harness 4 m	X40GPS09OPRCA40	GPS09c Pro Open Roof version 	CAN AiM Harness 4 m 

Kit 20 Pro Open Roof, RS232 version

Description	Part number	The kit contains	
GPS09c Pro Open Roof version + RS232 Harness 2 m	X40GPS09OPRRS20	GPS09c Pro Open Roof version 	RS232 Harness 2 m 

Optional harnesses

Description	Part number	
Open CAN Harness 2 m	V02551770	
Open CAN Harness 4 m	V02551780	

Description	Part number	
Open CAN AiM Harness 2 m	V02551850	
Open CAN AiM Harness 4 m	V02551860	

Description	Part number	
Open RS232 Harness 2 m	V02551810	

Description	Part number	
Open USB Harness 0,5 m	V02551690	